

## Soldering Hints

- Put leads through mounting holes from the side with part outline. Ensure component evenly touch PCB.
- Solder leads at the other side. Solder should fully fill and cover soldering pads. Avoid bridges between neighboring pads.
- Cut unused leads flush with cutter.

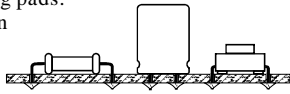

## DSO 138 Oscilloscope DIY Kit

# User Manual

Rev. 04

Applicable models: 13803K, 13804K

### Tools you need

- Iron (20W)
- Solder wire
- Multimeter
- Screw driver
- Flush cutter
- Tweezers

### Before you start

- Check part values & quantities against part list
- Always meter resistor values before soldering
- Understand all part polarities and orientations

### Important !!!

Install all SMD parts before proceeding to Step1 if you purchased kit 13804K.

## Step 1

### Assembly Main Board and LCD board (follow the order as numbered)

### 1. Resistors

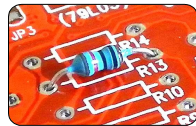

**Note:**  
Always meter resistor values before soldering

- R1, R14, R16 : 100K  $\Omega$
- R2 : 1.8M  $\Omega$
- R3 : 200K  $\Omega$
- R4 : 2M  $\Omega$
- R5 : 20K  $\Omega$
- R6 : 300  $\Omega$
- R7, R36 : 180  $\Omega$
- R8, R12, R13 : 120  $\Omega$
- R9, R15, R26 : 1K  $\Omega$
- R10 : 3K  $\Omega$
- R11 : 150  $\Omega$
- R38 : 1.5K  $\Omega$
- R28, R40 : 470  $\Omega$
- R37, R39 : 10K  $\Omega$

### 2. HF-Chokes



- L1, L3, L4 : 100  $\mu$  H

### 3. Diodes



Cathode

- D1 : 1N5819
- D2 : 1N4004 (or 1N4007)

### 4. Crystal



- Y1 : 8MHz

### 5. USB Socket \*

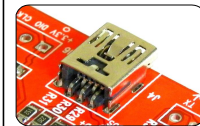

- J4 : USB mini -B

**Note:**  
This connector is optional.

### 6. Tact Switches



- SW4, SW5 : 6 X 6 X 5mm
- SW6, SW7, SW8

### 7. Ceramic Capacitors

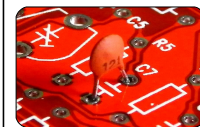

- C1, C9, C10, C11, C14, C15, C16, C17, C18, C20, C23 : 0.1  $\mu$  F
- C2 : 330pF
- C3 : 3pF
- C5 : 1pF
- C7, C8 : 120pF
- C12, C13 : 22pF

### 8. LED



Solder positive pole (the longer lead) to the square pad



- D3 :  $\phi$  3mm, green

### 9. Pin header (for power)

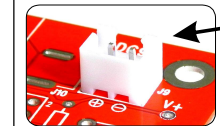

Face the opening outward

- J9 : 2 Pin

### 10. Transistors

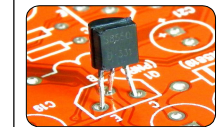

- Q1 : 8550
- Q2 : 9014

**Attention!**  
Packages are similar. Do not mix up!

### 11. Regulators

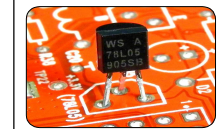

- U4 : 79L05
- U5 : 78L05

**Attention!**  
Packages are similar. Do not mix up!

### 12. Capacitor trimmers



- C4, C6 : 5 - 30pF

### 13. Power inductor



- L2 : 1mH/0.5A

### 14. Electrolytic capacitors

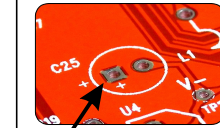

Solder positive pole (the longer lead) to the square pad



- C19, C21, C22, C24, C25, C26 : 100  $\mu$  F/16V

### 15. Power connector

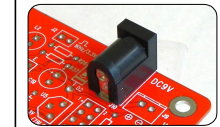

- J10 : DC005

### 16. Pin-header (male) \*

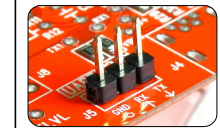

- J5 : 1 X 3 pin
- J6 : 1 X 4 pin

**Note:**  
These pin-headers are optional.

### 17. Pin-header (female)

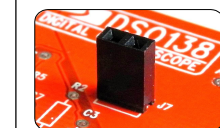

- J7, J8 : 1 X 2 pin
- J3 : 2 X 20 pin

### 18. Slide switches

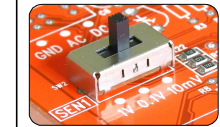

- SW1, SW2, SW3 : 2P3T

### 19. BNC connector

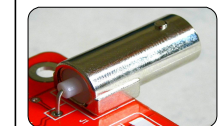

- J1 : BNC

**Note:**  
The thicker pins need to heat up longer to get good soldering result.

## 20. Test signal ring

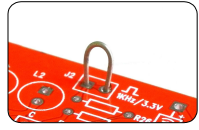

- 1) Make a small ring with a lead cut-off.
- 2) Solder the ring to the two holes of J2 (as shown in the photo).

## 21. JP3



Short JP3 with solder

## 22. LCD Board

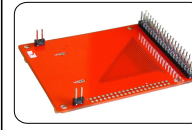

**Note:** Install to the side opposite to LCD panel.

- J1 : 2 X 20 pin
- J2, J3 : 1 X 2 pin

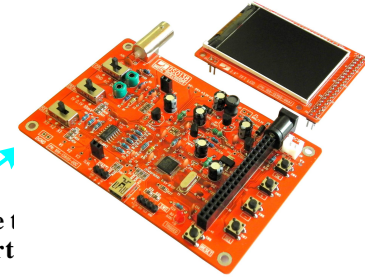

The assembly should look like 1 after you have finished all part

## Step 2 Test and Use

**NOTE:** You need a 9V DC power supply (at least 200mA capacity) to run the scope. This power supply is not included in the kit.

### A. Check voltages

- 1) Apply 9V power to J10 (or J9).
- 2) Check voltage at TP22. It should be around +3.3V.
- 3) If voltage at TP22 is good disconnect power. Short JP4 with solder permanently.

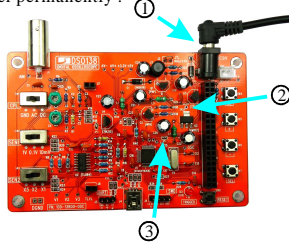

### B. Attach LCD board

Plug LCD board into the female headers J3, J7, and J8 on the main board.

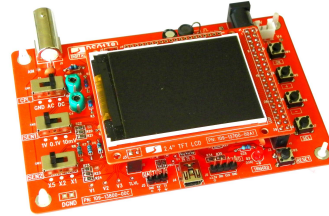

### C. Verify

- 1) Connect power supply again. You should see LCD lights up and oscilloscope panel displayed.
- 2) Press various buttons and move switches to verify their functions.

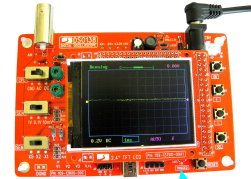

"Trigger" LED blinking twice indicates booting-up is good.

### A. Use

- 1) Attach probe clips to J1.
- 2) Touch the red clip with your finger. Do you see signal from your finger?

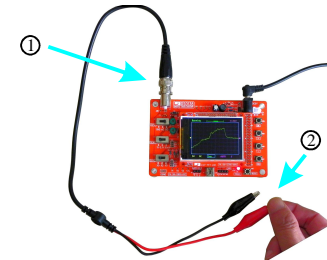

## Troubleshooting

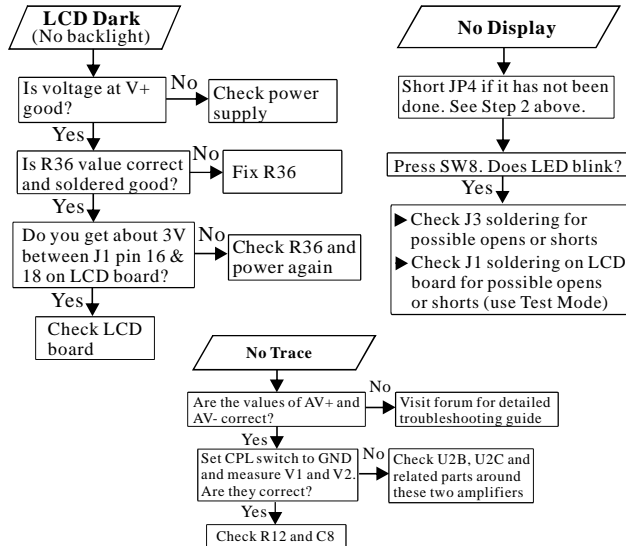

**NOTE 2:** LED will be blinking constantly if MCU (U1) can not detect valid LCD controller. Check LCD pin-header soldering.

**NOTE 1:** The voltages in the photo are for reference only. The voltages on your board could be different. But they should be close to the values shown.

**NOTE 3:** Make sure U1 and LED working (you see LED blinks twice at pressing RESET) before using Test Mode.

## Test Mode

### What it is and how it works

Test Mode is used to find out possible opens (for all port pins) and shorts (for pins PB0 - 15 and PC13-15). When entered it first checks PB and PC pins with special patterns to find out possible shorts. If found LED will be fast blinking. Otherwise, it generate 3.3V and 0V alternatively at each port pins (PA, PB, PC and PD) in cycle of about 4 seconds. These signals can be used to check for opens.

### How to use

1. Hold down SW4 and press RESET to enter Test Mode.
2. If you see LED fast blinking that means there are shorts on PB or PC pins. You need to find out the shorts first.
3. If you see LED slowly blinking use a volt-meter to check each pin related connections that are suspected open. When you don't see voltage change at a spot which is supposed being connected to a port pin there may be open between the spot and the port pin.

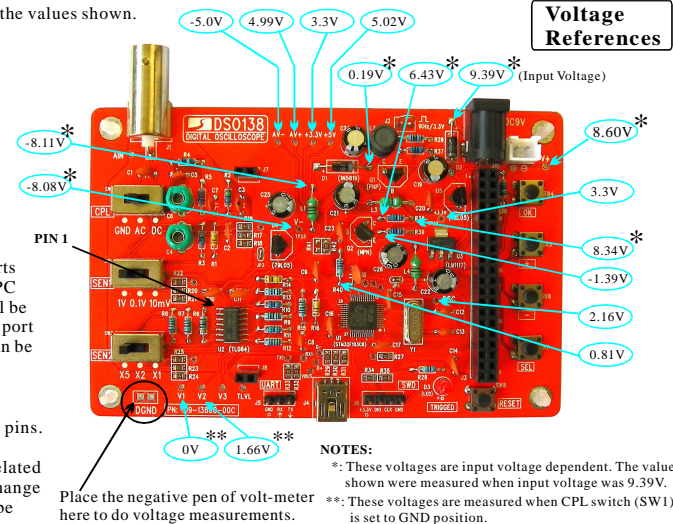

## Voltage References

**NOTES:**  
 \*: These voltages are input voltage dependent. The values shown were measured when input voltage was 9.39V.  
 \*\*: These voltages are measured when CPL switch (SW1) is set to GND position.

## Display and Controls

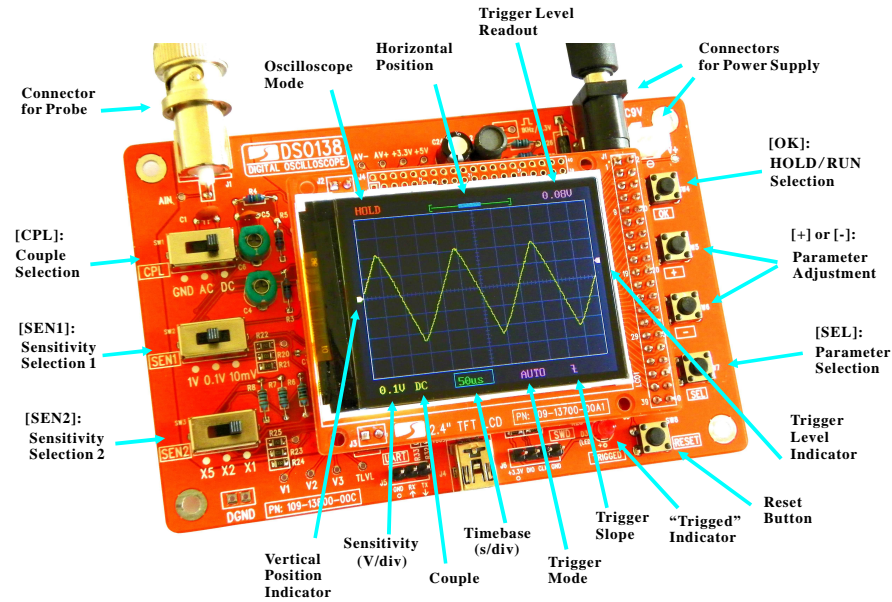

## Connections

**Power Supply:** Connect DC power supply to J9 or J10. The power supply voltage must be in the range of 8 - 12V.

**Probe:** Connect probe to J1.

**Attention**

1. Power supply voltage must not exceed 12V. Otherwise U5 will get hot.
2. Allowed maximum signal input voltage is 50Vpk (100Vpp) with the clip probe.

## Operations

**Press on [SEL] button:** Select parameter to be adjusted. The selected parameter will be highlighted.

**Press on [+ ] or [- ] button:** Adjust the parameter selected by [SEL] button.

**Press on [OK] button:** Freeze waveform refresh (entering HOLD state). Press on it again will de-freeze.

**Change [CPL] switch:** Set couple to DC, AC, or GND. When GND is selected the scope input is isolated from input signal and connected to ground (0V input).

**Change [SEN1] or [SEN2] switch:** Adjust sensitivity. The product of [SEN1] and [SEN2] settings makes the actual sensitivity which is displayed at the lower-left corner of the panel.

**Press on [Reset] button:** Perform a system reset and re-boots the oscilloscope.

### 0V Line Alignment

Sometimes you may find the 0V line (the trace corresponding to 0V input voltage) does not match with the VPOS indicator at the screen left border. This can easily be fixed by performing the "0V line alignment" function. First, set the couple switch [CPL] to GND position. Then press on [SEL] button to make VPOS indicator highlighted and hold down [OK] button for about 2 seconds. You will set the trace aligned to VPOS indicator when you release [OK] button. You may see some residue mismatch remains at the highest sensitivity settings. This is normal.

## Probe Calibration

Because there is always some capacitance between scope input and ground probe needs to be calibrated to achieve better measurement results for high frequency signals. This can be done with the help of the built-in test signal. To do this please follow the steps below.

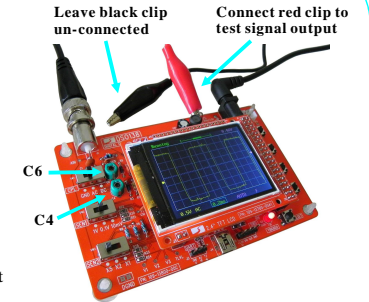

1. Connect the red clip to the test signal terminal and leave the black clip un-connected (see photo at right).
2. Set [SEN1] switch to 0.1V and [SEN2] switch to X5. Set [CPL] switch to AC or DC.
3. Adjust timebase to 0.2ms. You should see waveform similar to that shown in photos below. If traces are not stable adjust trigger level (the pink triangle on right screen border) so as you get a stable display.
4. Turn C4 (capacitor trimmer) with a small screw driver so that the waveform displays sharp rightangle (photo C).
5. Set [SEN1] switch to 1V and [SEN2] switch to X1 while keep all other settings unchanged. Adjust C6 so that sharp rightangle waveform is displayed.

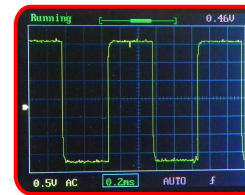

A - Not enough



B - Too much

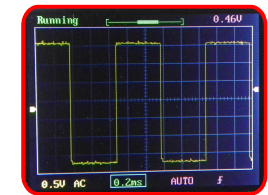

C - Good

### Turn On/Off Readouts

Press [SEL] so that timebase is highlighted. Hold down [OK] button for about 2 seconds. This will turn on/off measurement readouts.

### Waveform Save/Recall

Press [SEL] & [+ ] simultaneously: Save currently displayed waveform to non-volatile memory.  
Press [SEL] & [- ] simultaneously: Recall saved waveform

### Triggers and Their Modes

Triggers are events that indicate signal voltage acrossing a set level (i.e. trigger level) along a specified direction (i.e. trigger slope, rising or falling). Oscilloscope uses triggers as reference points in time for stable waveform display and measurements.

#### Auto Mode

In auto mode oscilloscope will perform display refresh no matter triggers happen or not. When triggers are detected waveform display will be displayed with reference to trigger points. Otherwise, display waveform at random reference points.

#### Normal Mode

In normal mode oscilloscope will only perform display refresh when there are triggers. If no triggers happen waveform display will stay unchanged.

#### Single Mode

Single mode is the same as normal mode except that oscilloscope will enter HOLD state after a trigger has been detected and waveform display has been updated.

Normal and single modes are useful for capturing sparse or single waveform.

Specifications	
Max realtime sample rate	1MSa/s
Analog bandwidth	0 - 200KHz
Sensitivity range	10mV/div - 5V/div
Max input voltage	50Vpk (1X probe)
Input impedance	1M ohm/20pF
Resolution	12 bits
Record length	1024 points
Timebase range	500s/Div -- 10us/Div
Trigger modes	Auto, Normal, and Single
Trigger position range	50%
Power supply	9V DC (8 - 12V)
Current consumption	~120mA
Dimension	117 x 76 x 15mm
Weight	70 gram (without probe)

Tech Support: [www.jytech.com/forum](http://www.jytech.com/forum)



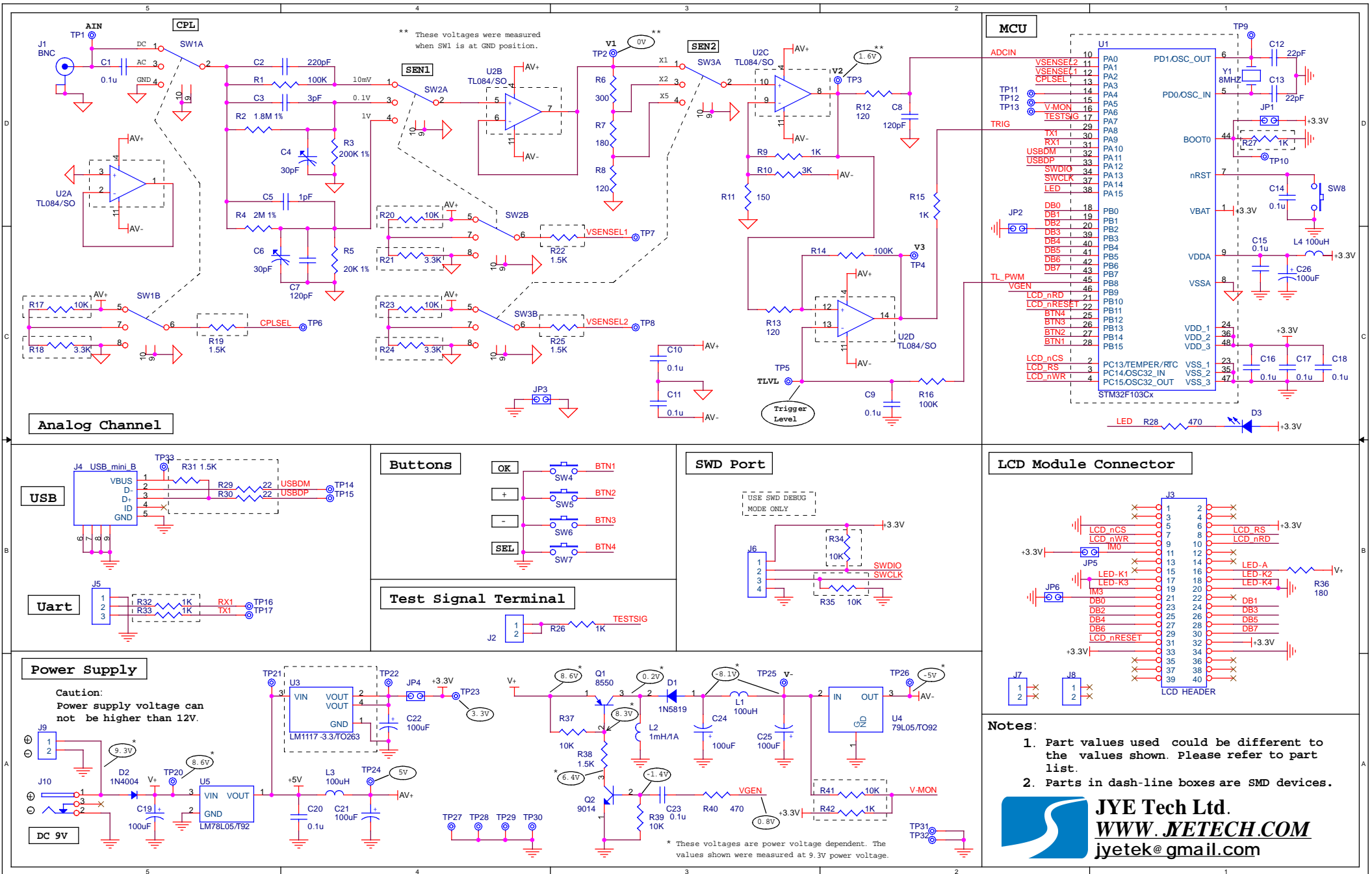

**Analog Channel**

**USB**

**Uart**

**Buttons**

**Test Signal Terminal**

**SWD Port**

**LCD Module Connector**

**Power Supply**

**Caution:**  
Power supply voltage can not be higher than 12V.

**Notes:**

1. Part values used could be different to the values shown. Please refer to part list.
2. Parts in dash-line boxes are SMD devices.

**JYE Tech Ltd.**  
[WWW.JYTECH.COM](http://WWW.JYTECH.COM)  
 jyetek@gmail.com